



# Just the Facts

## MidNite Solar Classic

### Quick Start Guide 12/03/13



This “Quick Start” is intended to be a supplement to the Classic owner’s manual. It is intended to give the basics of setting up your new Classic, when installed in a typical installation. Please refer to the Classic Owner’s Manual (Included DVD or visit [www.midnitesolar.com](http://www.midnitesolar.com)) for all advanced features, safety warnings and specifications

Este manual también está disponible en Español. La versión en Español puede encontrarse en nuestra pagina web en la ficha Documentos y haga clic en Manuales.

Ce manuel est également disponible en français. La version française peut être trouvé sur notre site web sous l'onglet Documents, puis en cliquant sur les manuels.

## Just the Facts for the Classic (continued)

---

The MidNite Solar Classic charge controller conforms to *UL 1741, Safety for Inverters, Converters, Controllers and Interconnection System Equipment for Use With Distributed Energy Resources, Second Edition, May 7, 1999 with revisions through January 28, 2010 and CAN/CSA C22.2 No. 107.1: 2001/09/01 Ed: 3 (R2006)*

### Notice of Copyright

MidNite Solar's Classic charge controller User's Manual  
Copyright © 2010, 2011 all rights reserved.

MidNite Solar Inc. reserves the right to revise this document and to periodically make changes to the content hereof without obligation or organization of such revisions or changes unless required to do so by prior arrangement.

### Disclaimer

Unless specifically agreed to in writing, MidNite Solar Inc.

(a) Makes no warranty as to the accuracy, sufficiency or suitability of any technical or other information provided in its manuals or other documentation.

(b) Assumes no responsibility or liability for loss or damage whether direct, indirect, consequential or incidental, which might arise out of use of such information. The use of any such information will be entirely at the user's risk.

### Contact Information

Telephone: 360.403.7207

Fax: 360.691.6862

Email: [customerservice@midnitesolar.com](mailto:customerservice@midnitesolar.com)

Web: [www.midnitesolar.com](http://www.midnitesolar.com)

## Just the Facts for the Classic (continued)

---

### Contents

<b>Inside view of the Classic</b> .....	4
<b>Ground fault and Arc fault settings</b> .....	6
<b>Non Solar inputs to the Classic</b> .....	6
<b>Wiring the Classic</b> .....	7
<b>Mode is Off</b> .....	7
<b>LED Modes and the “Blinking Red LED”</b> .....	8
<b>Restoring to Factory Default</b> .....	8
<b>Initial power up / Quick Start</b> .....	10
<b>Classic Menus and their adjustments / Factory default settings</b> .....	13
<b>Charging Voltage, Time and Limits adjustments</b> .....	17
<b>Setting the Date and Time</b> .....	18
<b>Auto Equalization (AUTO EQ)</b> .....	19
<b>Graphical Logging Display modes</b> .....	22
<b>Troubleshooting</b> .....	24

### Inside view of the Classic

Take care when removing the front cover from the Classic. The graphics display panel (MNGP) may be attached to the main circuit board with a blue phone style cable as seen below if this is not the first time being opened. Unplug one end or the other and set the Front cover aside during wiring. When replacing the cover, be sure not to pinch the cable between the cover and the case and that the cable does not interfere with the components inside. You will also note the use of the top jack. For explanation of the other 2 jacks and networking diagrams please refer to the Classic User's Manual (DVD).

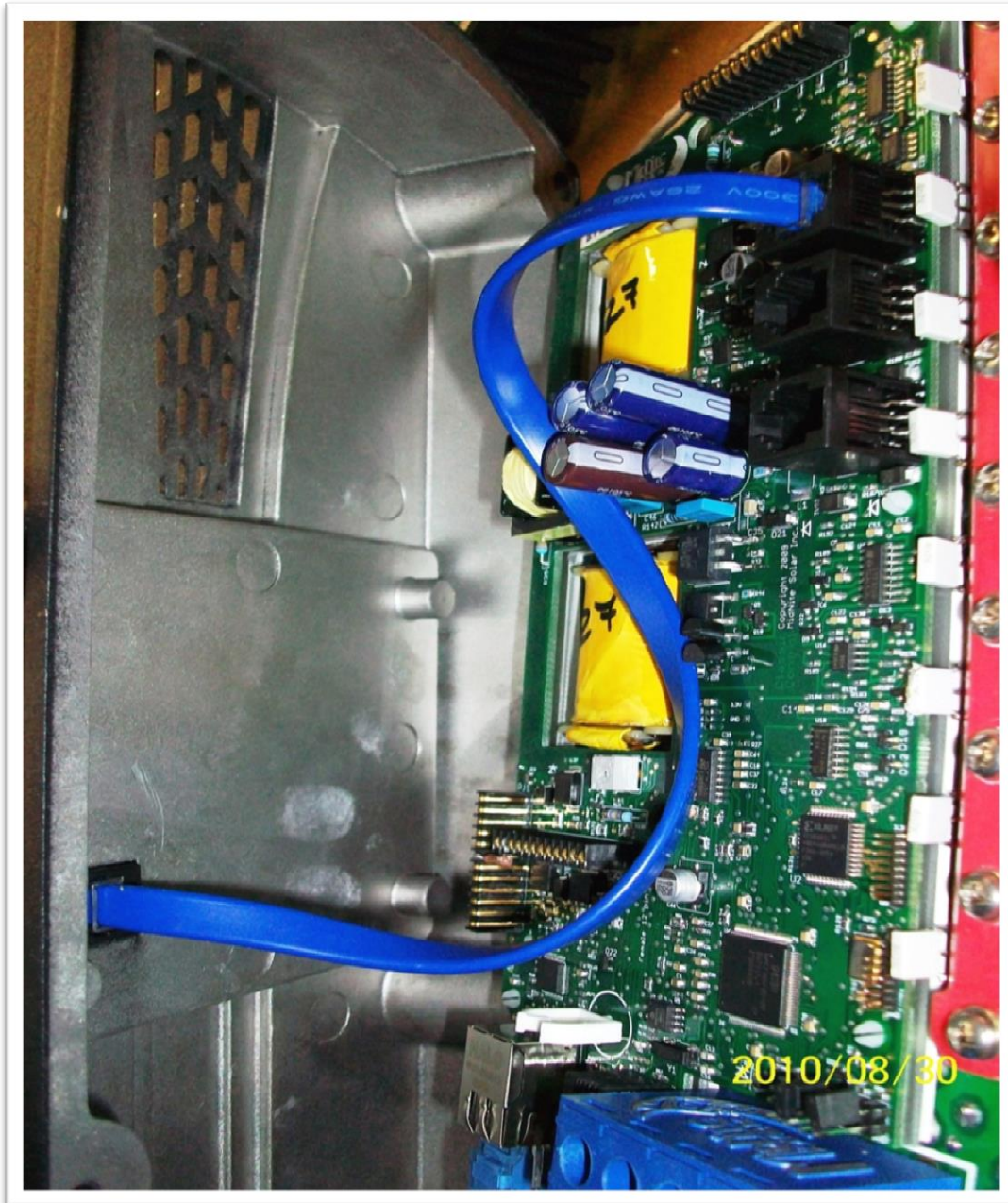



## Just the Facts for the Classic (continued)

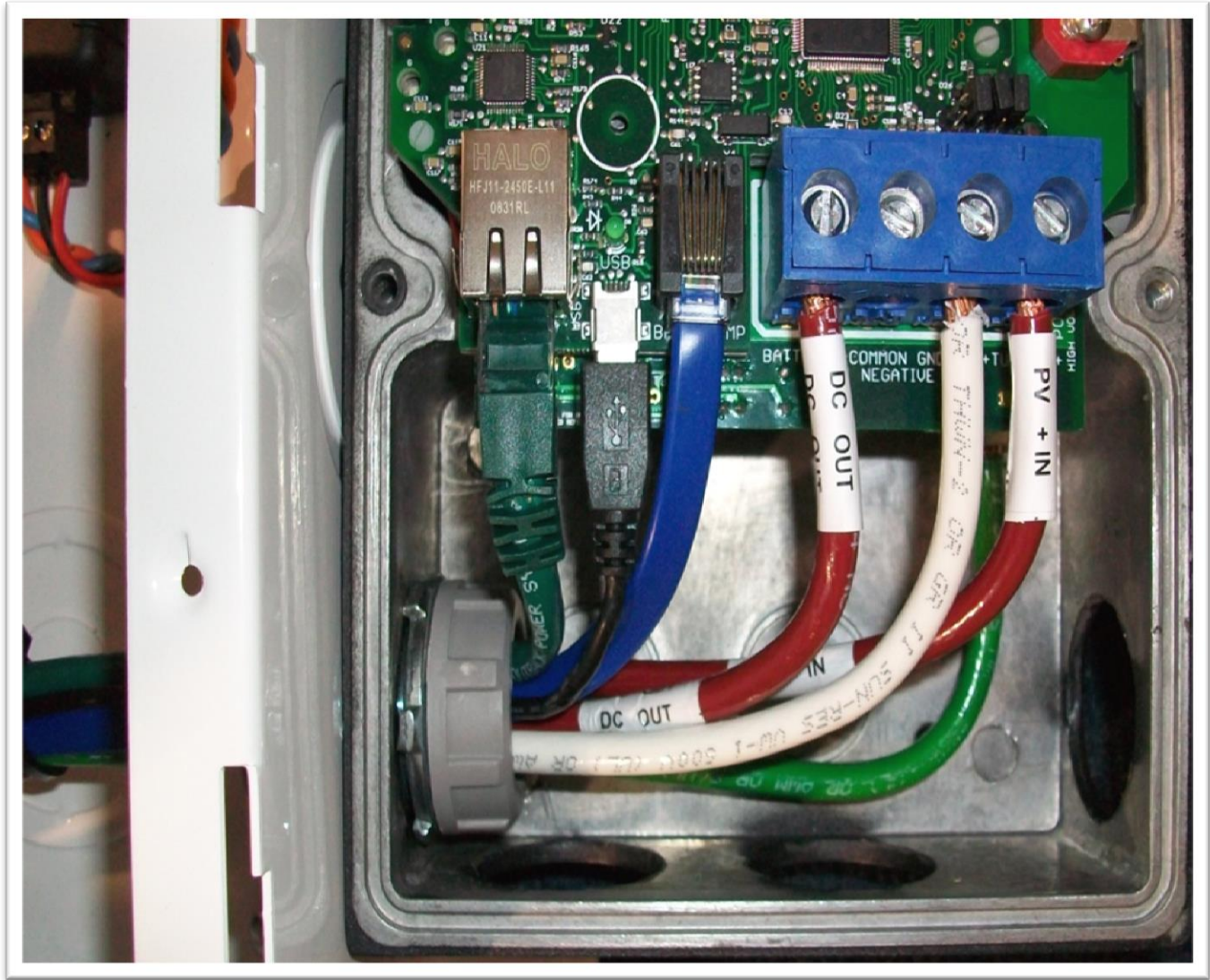

Figure 1

In [Figure 1](#) above we show from Left to Right, the Ethernet connection to your Router or wireless bridge, USB cable for updating firmware and the Battery Temperature sensor. On the blue terminal block from left to right Battery positive, common negatives and DC input positive. You only need to bring a single Negative conductor to the Classic if you have landed PV- onto the battery negative buss in the E Panel. Both can be used if preferred.

### Ground fault and Arc fault settings

There is a 2 pin header to the right of the blue terminal block for Ground Fault Protection as seen below. The supplied jumper must be installed across both pins as well as GFP enabled in the “Tweaks” menu in order for GFP to operate. To enable GFP in the Tweaks menu push the Main Menu button repeatedly until “Charge” is highlighted. Scroll to the right until “Tweaks” is highlighted, then press “Enter”. Push the right soft key labeled “More” once. Now scroll to the right until the “on” or “off” under “GF” is highlighted. Use the up / down arrow buttons to change it to the desired setting and press “Enter”. Please note that the above menu is the same menu where you would enable or disable Arc Fault (AF). And pressing “Arc Adjust” when in this menu will take you to the sensitivity adjustments for the Arc Fault Detection system. In this menu there will be 2 adjustments you can change to make the Arc Fault less sensitive. You can change the “Time” and the “Sensitivity”. The higher the numbers the LESS sensitive the Arc Fault Detection will be. Press “Enter” to save the changes and then power the Classic down and back on to make these changes take effect.

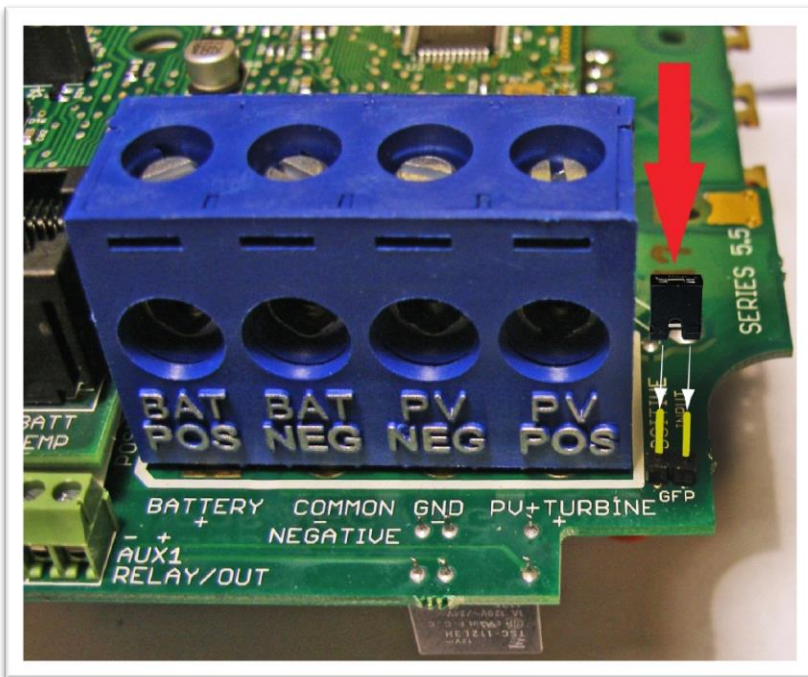

Figure 2

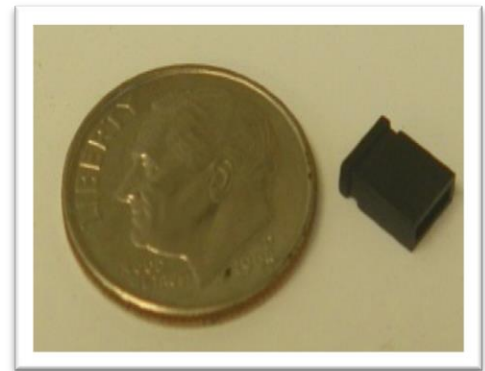

Figure 3

### Non Solar inputs to the Classic

The Classic will accept a wide variety of DC inputs from sources like Solar, Wind, Hydro, Fuel Cells ETC. One of the biggest concerns when hooking the Classic to alternative sources of DC is the Voltage. Exceeding the Classics Voltage window will cause damage to the Classic.

**Exceeding the Classic's Voltage window will cause damage to the Lite.**

If the source is unregulated and can exceed the Classics voltage a Clipper will be needed to assure the Classic never has its voltage ratings exceeded.

For more info on alternative inputs to the Classic please consult the Classic owner's manual or contact technical support [techsupport@midnitesolar.com](mailto:techsupport@midnitesolar.com) or 360-403-7207

## Wiring the Classic

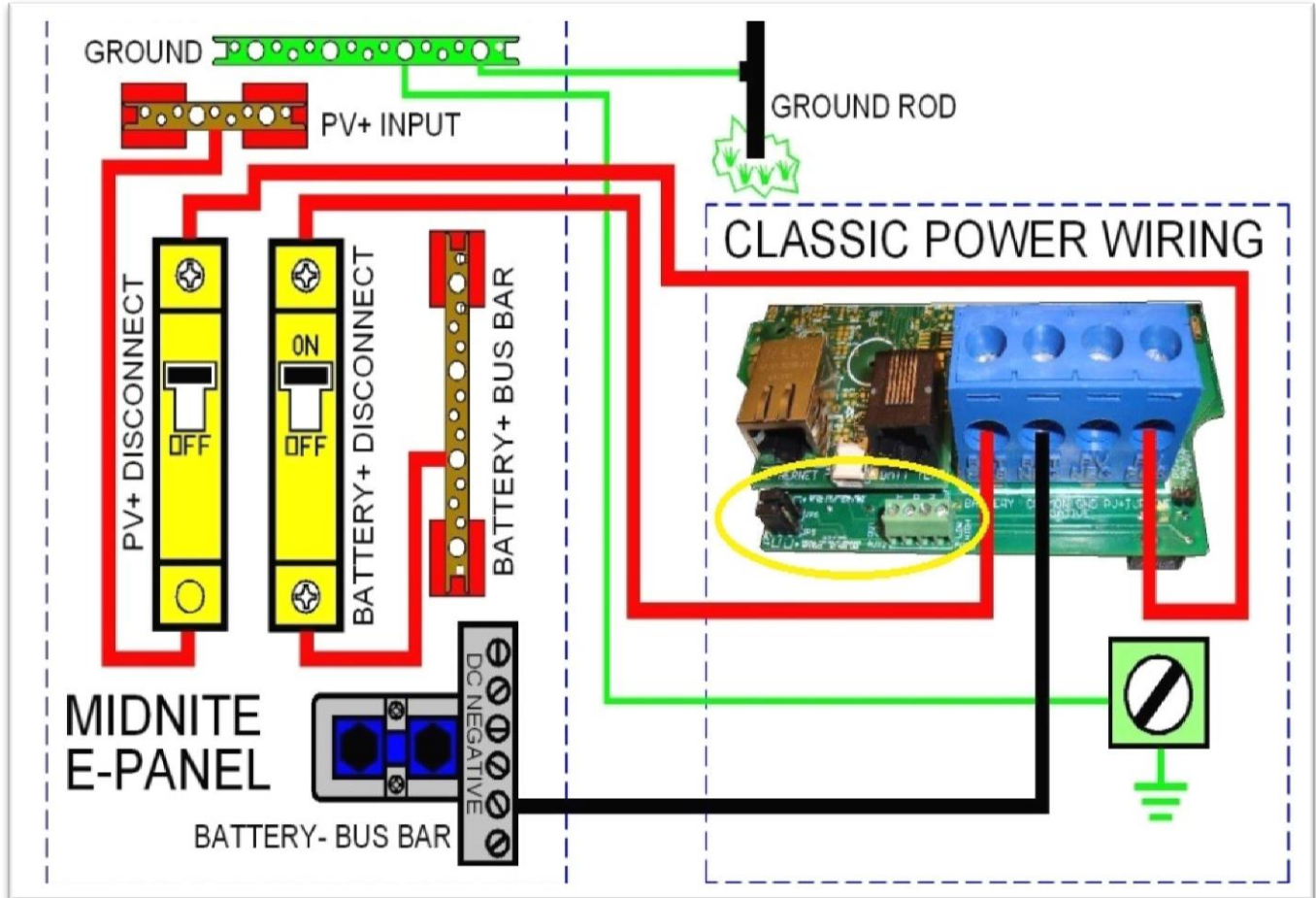

Figure 4

Above is a basic wiring diagram for installing the Classic on an E Panel. Some installations may vary. Please consult the Classic Owner's Manual for other diagrams. There are 2 jumpers and a 4 position terminal strip (Seen in the yellow oval above) for Aux 1 and 2 please refer to the Classic owner's manual for details on how to connect and use these.

## Mode is Off

The Classic is unique, it has multiple charging algorithms for just about any DC input. Because we support such a wide variety of DC inputs we have also added a software "ON" and "OFF" feature. This software "Switch" basically turns the relay off effectively disconnecting the input source so the Classic will not charge the battery. If you see "Mode is Off" in the bottom right corner of the display then the Mode may have got turned off. To turn the mode back "ON" push the Main Menu button several times until "Charge" is highlighted. Scroll to the right until "Mode" is highlighted and press "Enter". On this screen "OFF" should be highlighted use the up or down arrow to change it to "ON" and press "Enter". Press the Status button once to return to the main status screen.

Note: This is the same menu you would use to change between Charging algorithms IE Solar, Hydro etc.



### LED Modes and the “Blinking Red LED”

The Classic may have a Red Blinking LED on its display. This has no effect on the Classic and simply shows it is communicating with the Display. New Classics ship with this disabled. Below we will explain the different LED Modes. To change the LED Mode press the “Main Menu” button repeatedly until “Charge” is highlighted. Scroll to the right until “Misc” is highlighted and press “Enter”. Now scroll to “LED-Mode” and press “Enter”. Here you can use the up and down arrows to select the mode you prefer. After selecting the appropriate LED Mode press “Enter” to save this data to the Classic. Pressing “Status” will now bring you back to the home screen.

OFF – No LED activity no matter what

Rick Mode – LED Activity for Errors and Warnings only. (Over current, Arc Fault Etc)

Blinky – basically cycles all the LEDs in a Disco fashion (Useful for Partys)

LED 1 – LED activity for Warnings and Errors as well as info. A green LED on the display indicates the Classic is in Float. A yellow LED on the display indicates a warning (Over Temp, over current etc). A red LED on the Display indicates an Error (Arc Fault etc). There is also 3 LEDs inside the Classic that can be viewed through the upper vents. The red LED indicates Auxiliary 1 is active. The blue LED is not used at this time and the yellow LED indicates Auxiliary 2 is active

### Restoring to Factory Default

To restore to Factory defaults you will simply need to do a “Quick Start” this will reset EVERYTHING to the way it was from the factory. To do a Quick Start, start with the power off to the Classic. While holding the right and left arrows power up the Classic and continue to hold the arrows until you see the screen below. For assistance with the 4 set up screens in the Quick Start see page [10](#)

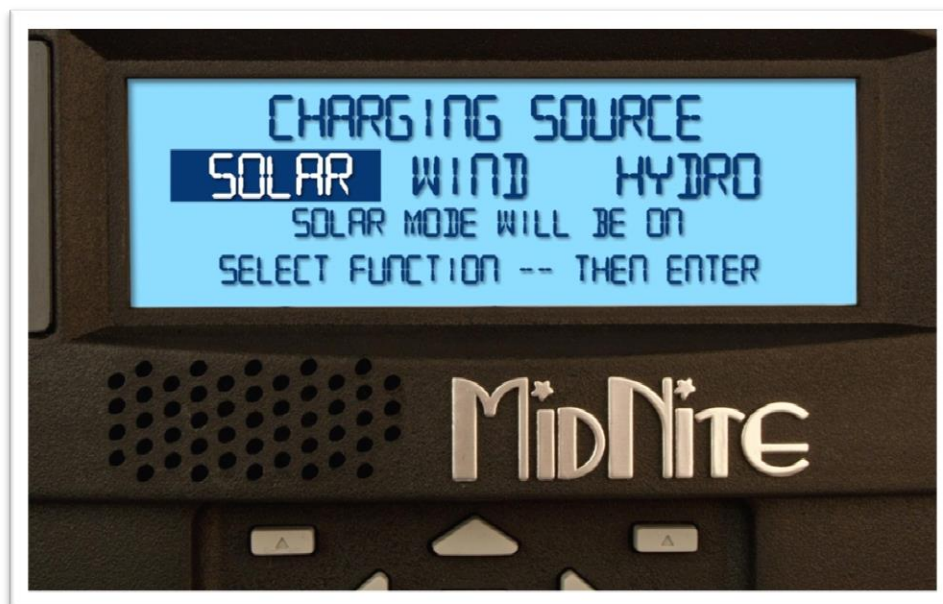

Figure 5



## Removing the instructions and battery insulator from the MNGP



Figure 6

There is a white paper instruction sheet behind the window in the MNGP as shown in [Figure 6](#) above. This needs to be removed. There is also a paper insulator behind the small coin battery that needs to be removed for the Clock and non-volatile memory to store its data when the Classic is powered down.

First, turn the DC input and output breaker “off” to de energize the Classic. You will need to gently pull the front cover off the MNGP. With the cover removed you can slide the paper out from behind the battery. You may want to use your finger nail to hold the battery in while doing this so it does not fall out. You will need to plug the speaker wire in as seen below. (It is not polarity sensitive) When re-installing the cover take care to get all the rubber buttons through their holes in the face of the MNGP.

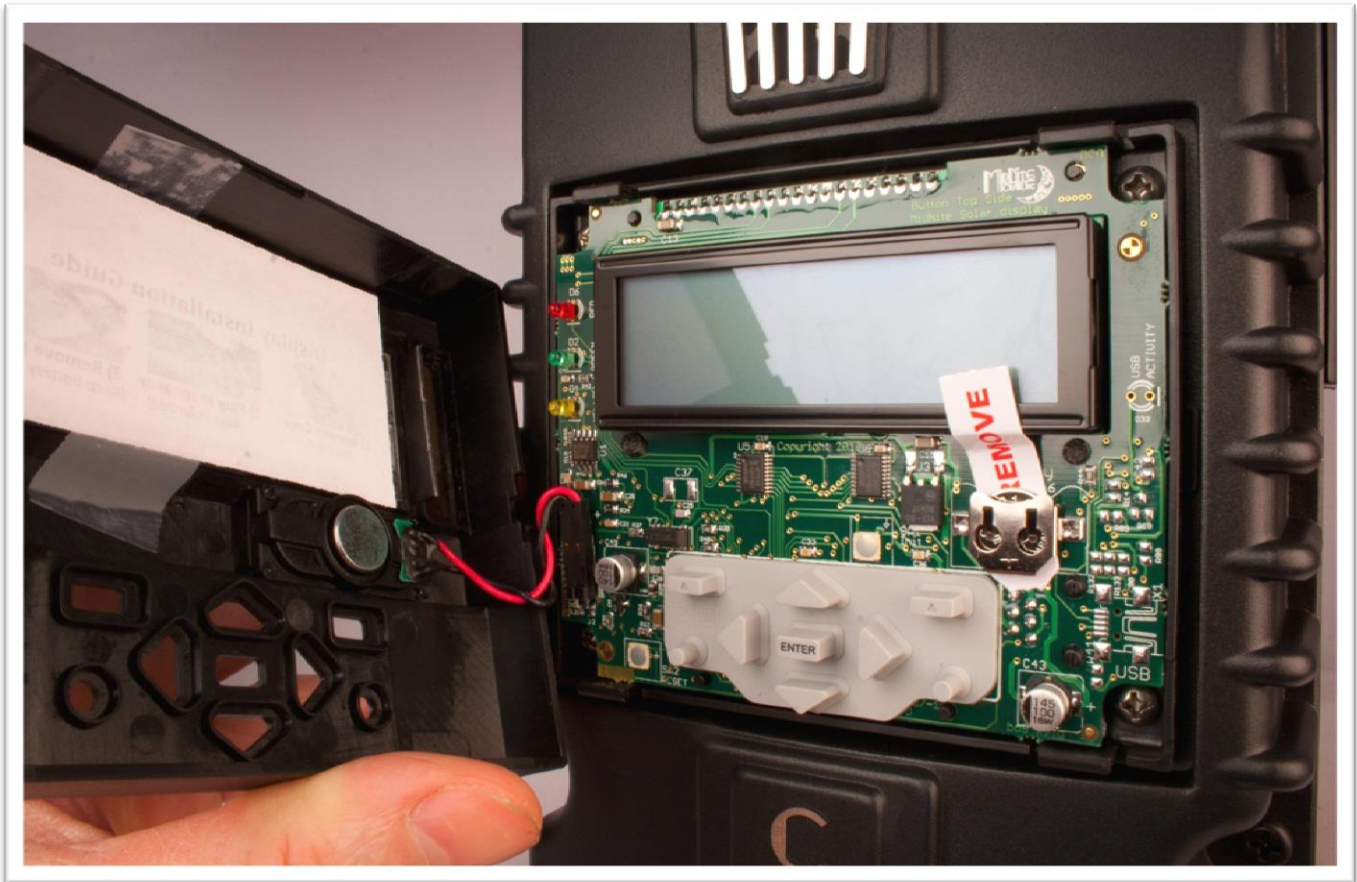

Figure 7

### Initial power up / Quick Start

On initial power up the Classic should come up in the “Quick Start” with a startup screen as shown below. If this screen does not show up, or if you would like to change the battery voltage, hold the left and right arrow buttons while turning on the battery breaker to power up the Classic. Continue to hold them until the set up screen is displayed as seen below.

**NOTE:** This will restore all settings back to factory defaults even custom settings like Aux 1 and 2

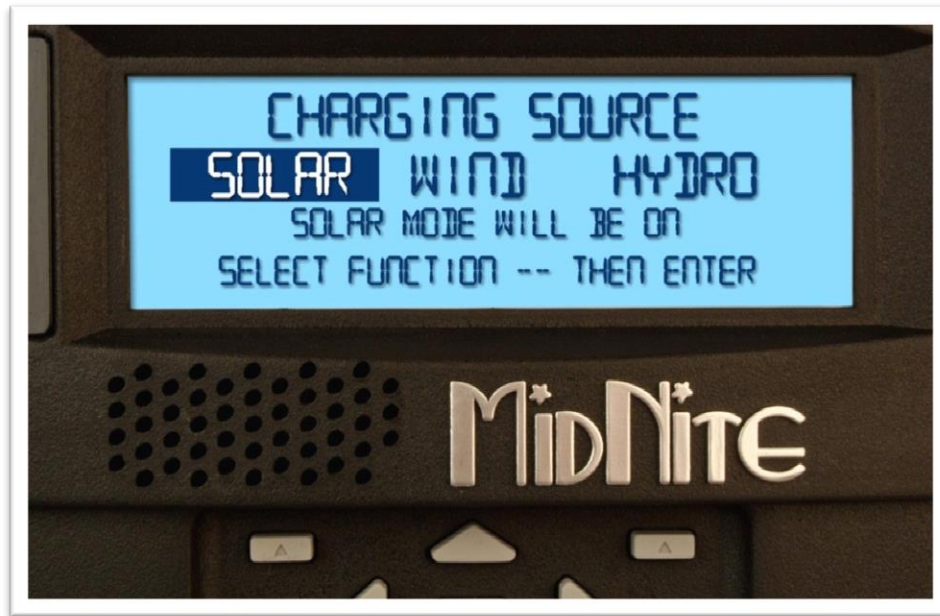

Figure 8

Make your selection for “Solar” ”Hydro” or “Wind” using the right and left arrows to scroll and press “Enter”. Please note that almost all types of dc power sources are supported, even though they are not included in this set up. Please refer to the Classic Owner’s Manual for instructions on the proper settings for these alternative input sources.

Pushing “Enter” on the previous screen will bring you to the battery voltage quick set screen shown below. The Classic will check the system voltage and ask you to verify the correct voltage. If you would like to select a voltage other than the one shown, use the up and down arrows to select your battery voltage and press “Enter”

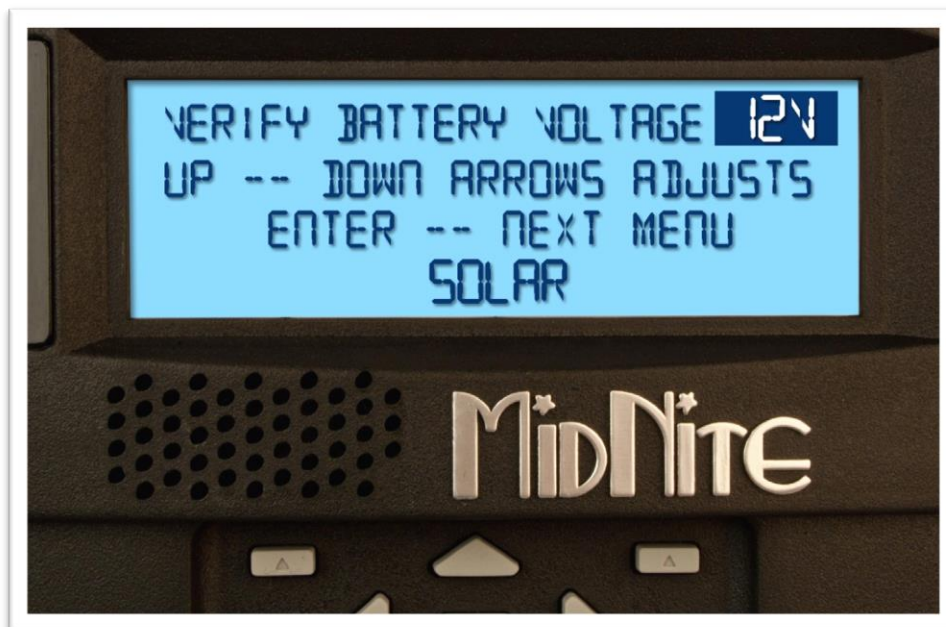

Figure 9



## Just the Facts for the Classic (continued)

Pressing Enter on the screen shown above brings you to the Battery Charging Set point menu. This allows you to set the Equalize voltage, Absorb voltage and Float voltage. These values should have been supplied by the battery manufacturer. MidNite sets these to a low default so not to cause any damage to a sealed battery. You will want to adjust these to the specs of the particular battery you have. After setting all three press Enter to move to the Date and Time Screen.

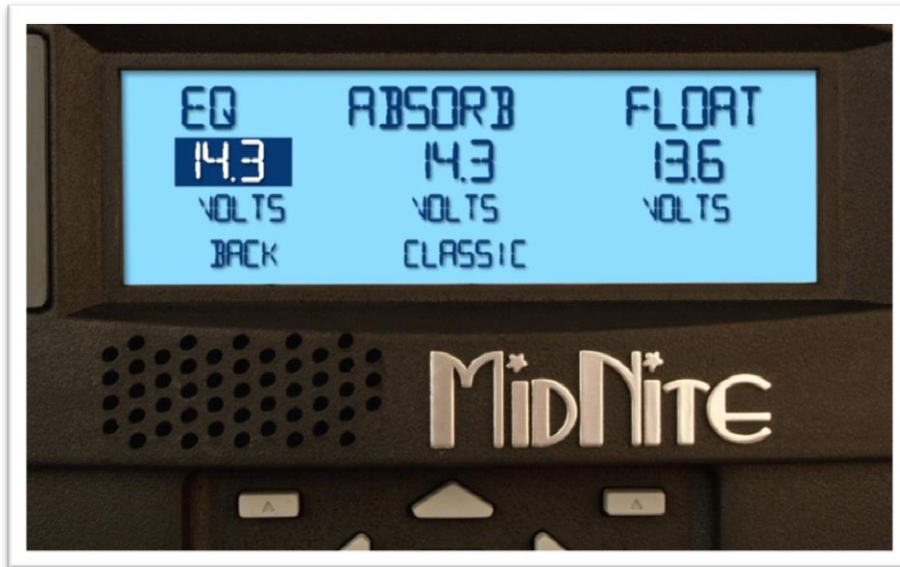

Figure 10

The Time and Date screen will appear as shown below. The time is in the 24 hour format. Set the date and time correctly and press “Enter” this will save all the settings and boot up the Classic. It will go through a couple status screens and eventually stop at the Home screen and be ready to charge the batteries.

**NOTE:** If using Wind or Hydro more advanced set up is required please consult the Classic Manual for the set up procedures.

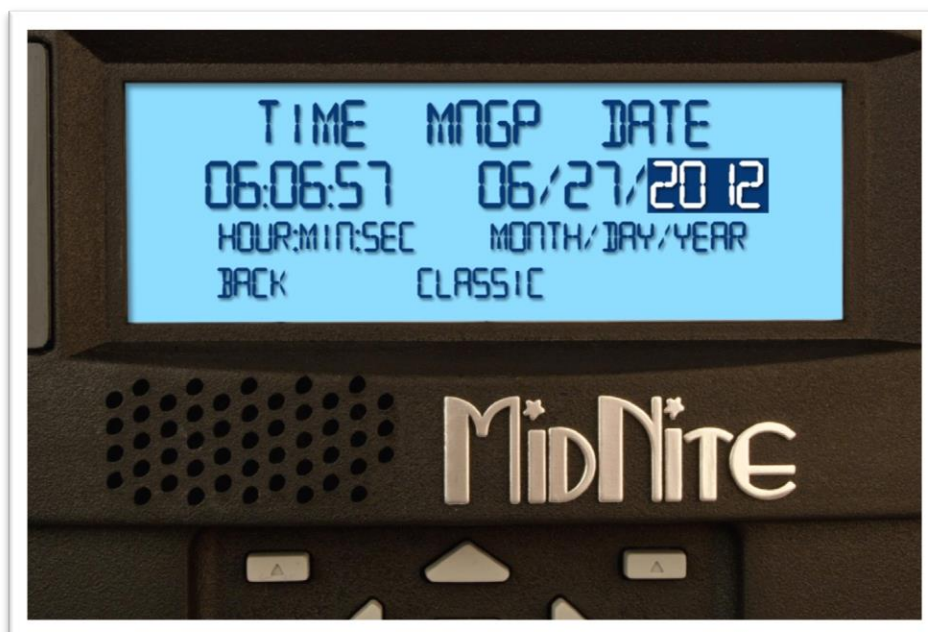

Figure 11



### Classic Menus and their adjustments / Factory default settings

A brief explanation of all the Classic menus and there adjustments. To enter into the Menu's press the "Main Menu" button repeatedly until "Charge" is highlighted. This is the start of the Menu tree. Note these are in the order they actually appear in the Classic.

#### Charge

##### Volts.

**EQ** this is the Equalization voltage the Classic will target. This is fully adjustable from the Absorb set point up to the limit of the Classic.

**Absorb** this is the voltage the Classic will switch from Bulk MPPT to Absorb at. It will maintain this voltage for a specified period of time. This is fully adjustable from 0.1 volts above float to the limit of the Classic.

**Float** this is the voltage the Classic will float at after it completes the absorb cycle. This voltage is adjustable from 0 to 0.1 volts below the absorb set point.

Battery Voltage	12v	24v	36v	48v	60v	72v
Bulk MPPT	14.3v	28.6v	42.9v	57.2v	71.5v	85.8v
Float	13.6v	27.2v	40.8v	54.4v	68.0v	81.6v
Equalize	14.3	28.6v	42.9v	57.2v	71.5v	85.8v

##### ChgTime

**Absorb Minimum** this is the minimum time the Classic will spend in Absorb before switching to Float. Default is 30 minutes. This is adjustable from 0 to the same amount of time as the maximum absorb time

**Absorb Maximum** this is the maximum time the Classic will spend in Absorb before switching to Float. Default is 2 hours. This is adjustable from the time set in minimum absorb time to 18 hours.

**EQ** this is the time the Classic will spend at the Equalization voltage. Default is 1 hour. This is adjustable from 0 minutes to 18 hours.

**Timer VW** this will show the minutes the Classic is at in the Absorb, EQ or Float stage.

##### T-Comp

Here we set the value the Classic will use to calculate the adjustment to the charge stage voltage it is targeting. The value is milli Volts per degree C per cell. So if you have a 12 volt battery you have 6 cells. The default value is -5.0mV this can be adjusted from disabled to -10 mV in 0.5 mV increments.

**EQ Comp'd** this allows you to adjust the equalize voltage based on battery temperature if it "Yes" is selected. Default is No

**View** This will allow you to see the Temperature corrected voltage the Classic is targeting at the moment.

## Just the Facts for the Classic (continued)

---

### EQ

Here you can use the up and down arrows to select between “EQ Started” or “EQ Stopped” this will start and stop a manual EQ.

**Auto EQ** this allows you to set up Auto EQ. You need to select the number of days between EQ charges as well as the number of days it will try to EQ for before “giving up”. If the Number of days between cycles is set to 0 it will show “Manual interval” this will require the user to actually initiate the EQ cycle. Default settings are Manual Interval. The days between EQ cycles can be set from 0 to 250 and the days to re try can be set from 0 to 1 day less than the Interval days.

**View** this shows the days until the next cycle. It is basically a countdown timer

### EndAmps

**Ending Amps** This is the Output Amperage set point the Classic will switch to Float at. Default is 0.1 and the adjustment is from 0 to the output current limit setting.

**Rebulk** This value is a voltage the Classic watches for when it is in Float. If the Battery voltage falls to this number when the Classic is in Float it will force a new Bulk Charge. Default is 8 volts and this is adjustable from 0 to the Float voltage set point.

### Limits

**Output Amps** This will set the maximum amount of amperage you want the Classic to allow out to the batteries. Default is the maximum allowed based on Battery voltage and Classic model. This is adjustable from 5 amps to the limit of this Classic in this setup.

**Input Amps** This will set the maximum amount of amperage you want the Classic to draw from its input source. Typically this is not used. Default is 99 amps and this is adjustable from 2 amps to 99 amps.

**Min T-Comp** This is the minimum voltage you will allow the Classic to compensate to for hot temperature on the batteries.

**Max T-Comp** This is the maximum voltage you will allow the Classic to compensate to for cold temperature on the batteries.

## Mode

**On/Off** This allows you to disable the charging function of the Classic similar to turning off the Input breaker. This needs to be turned On after changing modes. Also you need to press Enter after turning it on to save this data. The up or down arrows will turn it on or off.

**Mode** There are several Modes, these are the input source to the Classic. The Modes are Hydro, Solar, Legacy P&O, Wind Track, Dynamic and U-Set Voc%. Most of these modes have adjustments you can make to them. Solar mode defaults to the correct settings for normal PV arrays.

## Just the Facts for the Classic (continued)

---

### Aux

**AUX 1** This is where you configure the Auxiliary one relay. Default is Manual Off. Please consult the manual for Aux functions.

**AUX 2** This is where you configure the Auxiliary one relay. Default is Manual Off. Please consult the manual for Aux functions.

### Misc

**Led-Mode** This allows you to select between several modes of operation for the LED's both in the Classic and MNGP. The default is "Rick Mode" this gives errors only. For more Led functionality please see the Manual.

**MNGP** Here you can adjust things like Backlight (Default is 400), Contrast (Default is 690) and Volume (Default is 600). You can also hit Play and it will play a beep to allow you to adjust Audio levels to your liking.

**Audio** Here you can select between the Modes of speech the Classic will use. (Not active yet)

**Comm** Here you can set the MNGP Address (Default is 110), USB mode (Default is 00) and the ModBus Port (Default is 502) These will all be fine the way they are unless you have multiple Classic's and need to change stuff. Please see the manual for advanced functions.

**Time** Here you can set or correct the Time and Date. This needs to be set correctly to assure the logged data is time stamped correctly. The Classic uses a 24 hour clock not an AM/PM clock.

**Pwrsv** Allows you to select the length of time the backlight on the MNGP stays on after the last button activity. Default is "OFF" meaning it will always stay on. There is a short (1 minute) and long (6 minutes) setting as well.

### Logs

**Life Time** Shows the life time Kilo Watt hours since the unit was commissioned there is also a "Time in Float" for today shown as well.

**Daily Logs** Allows you to scroll back through the previous 380 days of data. The prior day will be day 1 and it counts back from there. Not the days are also date stamped if the time and date were set correctly. Please consult the manual for the data that is viewable here as well as the graphs that are viewable.

**Hourly Logs** Allows you to view the previous 24 hours in 15 minute increments. Please consult the manual for the data that is viewable here as well as the graphs that are viewable here.

### Tweaks

**VBatt** Allows you to calibrate the battery voltage shown on the Classics screen to agree with the actual measured battery voltage. Default is 0 volts of offset and this is adjustable from -2.5 to 2.5 volts of offset. The Number below is the voltage that will be shown on the Classic screen. **NOTE if this value is off more than 1 volt please see the manual for calibrating the voltage using the potentiometer inside the Classic.**

**Vpv** Allows you to calibrate the input voltage shown on the Classics screen to agree with the actual measured input voltage. Default is 0 volts of offset and this is adjustable from -5 to 5 volts of offset.

## Just the Facts for the Classic (continued)

---

### “More”

**AF** This turns Arc Fault Protection on or off. Default is Off

**GF** This turns Ground Fault Protection on or off. Default is ON. Note the Jumper inside the Classic will need to be installed for Ground fault protection to be enabled as well. Default on the jumper is OFF

**LMX** LoMax allows the Classic to drag the input voltage down to the battery voltage. Default is ON. The only down side is when in LoMax the inductors can make a little singing noise. This does not hurt anything at all but some people find the noise bothersome. LoMax is the area from battery voltage at that time to 5 volts above battery voltage at that time.

**BLK** This is where you would force a Bulk charge. To force the bulk charge highlight the --- and press and hold the down arrow until you see OK flash for a second.

**FLT** This is where you would force a Float charge. To force the float charge highlight the --- and press and hold the down arrow until you see OK flash for a second.

### “More 2”

**A-Rst** This will make the Classic do a reboot at Midnight. Default is Off. This can be usefull for very remote sites where loss of network activity over the internet for example would be devastating.

**A-EQ-R** This will reload the EQ counters to start over on the cycle. To do this highlight the --- and press and hold the down arrow until OK flashes.

**DvrtCnt** This will allow the timers for the charge stages to run when diverting through Aux 1 or 2. Default is On

### “More3”

**Insomnia** When ON will not allow the Classic to go to Resting. Default is OFF. This is mainly intended for Hydro where you want the Classic to be awake and ready when you open the water valves. **Note: the Classic uses more power to be on and not charging than it does in Resting so this is not a desirable feature for low wattage PV arrays.**

**NiteLog** When ON will log data while the Classic is resting not just while it is active. Default is ON.

**Shade** When ON allows the Classic to display “PV Shading” when the input voltage is less than 50% of VOC. Default is OFF

### “Arc Adjust”

**Mode** Is default set to 1 and should stay on 1

**Time** Is the time the arc has to be seen for. Default is 4 and this is adjustable from 0 (Shortest) to 7 (Longest)

**Sensitivity** Is the sensitivity level setting. Default is 10 and this is adjustable from 0 (Most sensitive) to 15 (Least sensitive)

Note after changing the Arc Fault settings press enter to save and reboot the Classic to make them take effect.

## Temps

**Remote** This is the temperature in C of the MNGP circuit board



## Just the Facts for the Classic (continued)

---

**FETS** This is the temperature in C of the switching FETs internal on the Classic

**Battery** This is the temperature in C of the battery temperature sensor if plugged in

**PCB** This is the temperature in C of the Classics internal circuit board

### Net

**Mode** Sets the Classic to static IP address or Dynamic (DHCP) Default is DHCP

**IP** Lets you set the IP address if Mode is Static or shows the assigned IP address if Mode is DHCP

**SN** Subnet Mask: Advanced configuration. Depends on network class but for most cases will be (255.255.255.0).

*“Next”*

**GW** Gateway address: Advanced configuration. The IP Address of your Internet-connected Router (Usually 192.168.x.1 / 10.x.0.1)

**D1** Primary DNS Address: Advanced configuration. Primary DNS Address provided by your ISP. In some cases may be set to Gateway Address.

**D2** Secondary DNS Address: Advanced configuration. Secondary DNS Address provided by your ISP.

*“Advanced”*

**Web Access** Allows you to Enable or Disable the Classics web server. Default is Disabled. The web server is what allows the Classic to talk to our server storing data for you to access remotely via My MidNite

**MA** The Classics Mac address. This is not adjustable and is unique to every device

**DI** The Classics Device ID. This is not adjustable and is unique to every device

## Charging Voltage, Time and Limits adjustments.

There may be a desire to adjust the charge voltage, time set points and Limits to something other than the factory defaults.

### Voltage

Follow these instructions to change the EQ, Absorb and Float voltage set points. Press the Main Menu button repeatedly until “Charge” is highlighted and press “Enter”. Use the 4 arrow buttons to scroll and highlight “Volts” and press “Enter”. On this screen you will notice 3 voltage set points. The left and right arrow buttons scroll between the 3 voltage set points. The up and down arrow buttons will change the voltage set points. When all 3 set points are adjusted correctly press “Enter” to save the data to the Classic. When you are finished making adjustments press the “Status” button once to return to the main status screen.

Note: The EQ set point will not go below the Absorb set point. The Absorb set point will not go below the Float set point.

## Just the Facts for the Classic (continued)

---

### Time

Follow these instructions to change the Absorb Minimum and Maximum and Equalize times. Press the Main Menu button repeatedly until “Charge” is highlighted and press “Enter”. Use the 4 arrow buttons to scroll and highlight “ChgTime” and press “Enter”. On this screen you will notice 3 time set points. The left and right arrow buttons scroll between the 3 time set points. The up and down arrow buttons will change the time set points. When all 3 set points are adjusted correctly press “Enter” to save the data to the Classic. When you are finished making adjustments press the “Status” button once to return to the main status screen.

Note: The Classic will adjust the time it spends in Absorb based on the time it spends in Bulk MPPT. You will want to set the Minimum time accordingly. For more explanation on how the Classic calculates its time spent in Absorb please refer to the Classic Owner’s Manual.

### Limits

Follow these instructions to change the Maximum output and input current as well as the Minimum and Maximum temperature compensated voltages. Press the Main Menu button repeatedly until “Charge” is highlighted and press “Enter”. Use the 4 arrow buttons to scroll and highlight “Limits” and press “Enter”. On this screen you will notice 4 set points. The left and right arrow buttons scroll between the 4 set points. The up and down arrow buttons will change the set points. When all 4 set points are adjusted correctly press “Enter” to save the data to the Classic. When you are finished making adjustments press the “Status” button once to return to the main status screen.

Note: When upgrading firmware on Classics with firmware older than 11-7-11 the Input Current limit can be set to a randomly low number. Please refer to the Limits section above and adjust the “Input Current limit” to an appropriate level (Typically 99 amps). When upgrading firmware always check your custom settings to make certain nothing changed.

## Setting the Date and Time

The Classic internal clock itself is synchronized from the MNGP (remote) after first powered up, at night as the daily statistics are being stored or when the ENTER key is pressed in the MNGP MISC Time/Date set menu.

You need to set the date and time on the Classic so the Data Logging will be accurate. To set the date and time on the Classic push the Main Menu button several times until “Charge” is highlighted. Scroll to the right until “Misc” is highlighted and press “Enter”. Use the Left, Right, Up and down arrow buttons to scroll until “Time” is highlighted and press “Enter”. The left and right arrow buttons will scroll through the time and date settings. The up and down arrow buttons will change these set points. When you have the date and time set push “Enter”. When you are finished making adjustments press the “Status” button once to return to the main status screen.

If, for any reason, the Classic should erroneously time stamp a logging data point less than the year 2011, the displayed time and date in either DAILY or HOURLY modes will flash between the wrong date and the word INVALID. The word INVALID does not necessarily mean that the data itself is invalid... It may just mean that the time/date was not properly synchronized in the Classic from the MNGP at the time this data was captured.

### Auto Equalization (AUTO EQ)

The Classic can be set up to automatically equalize your batteries periodically, programmed as days between Equalization and the number of days the Classic will try to finish the programmed equalization charge cycle.

To set up Auto EQ go into the CHARGE menu and highlight "EQ" and press "Enter". Now press the SOFT RIGHT key labeled "AUTO EQ". Pressing the AUTO EQ soft key enters the Auto EQ setup menu screen. The left side of the EQ setup menu will show and select the number of days, or "interval" between auto EQ charge cycles. If set to zero (0), it will display MANUAL which is the same thing as DISABLED.

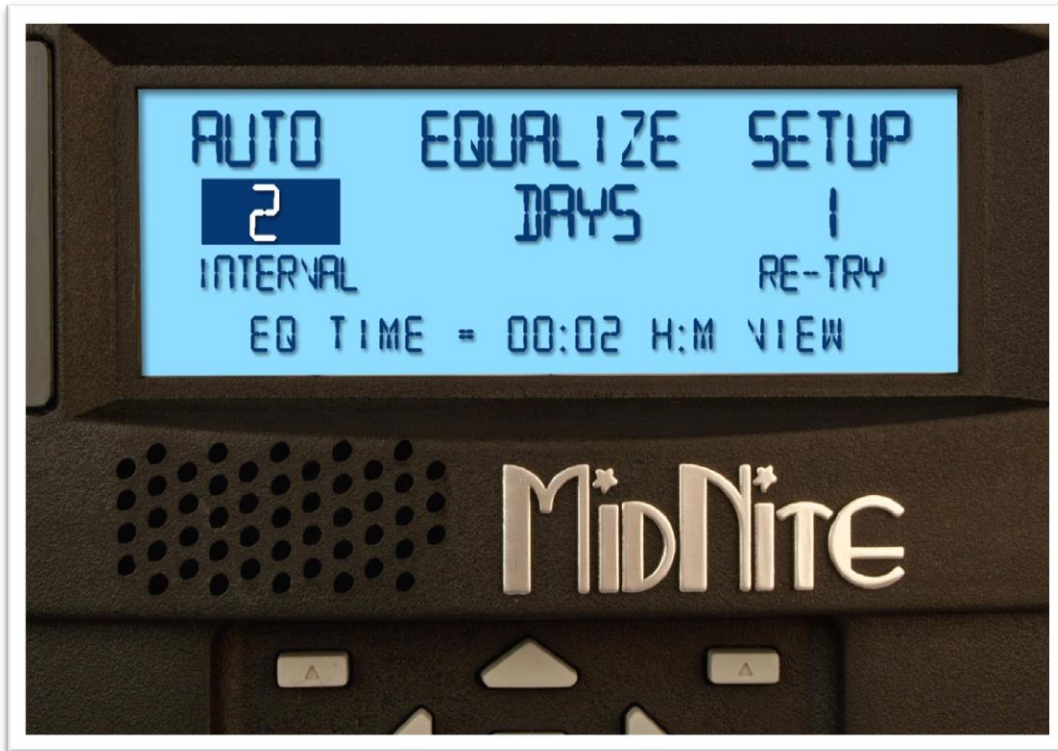

Figure 12

On the right side of the Auto EQ setup menu is the number of DAYS that the Auto EQ will retry if it does not finish the number of Hours and Minutes the Classic has been programmed to EQ for during the first day. For instance you set the Auto EQ for an interval of every 30 days and the RE-TRY for 3 days. Then the first day it attempts an EQ the Classic only accumulates 1 hour of a 2 hour EQ cycle, the next day the Classic will re attempt the EQ cycle. If the Classic still didn't finish the EQ cycle on the 2nd day of its 3 allotted re-try days, it will have one more day to try to finish the Equalize cycle. After this, if it did not complete the 2 hours of EQ time, it will not continue another day. The Classic will show "EQ DONE" on the status screen until either the start of the next day or until the user presses a button on the MNGP to stop it earlier.

At the bottom of the AUTO EQ screen shows the time, in hours and minutes, that the EQ is set for.

Pressing the Soft Right key, labeled "VIEW", takes you to a screen where you can view the interval and re-try counters (timers).

### Viewing Logged Data

The Classic logs 380 days' worth of data in its memory. The data logging in the Classic has two modes and frequency of data capture.

## Just the Facts for the Classic (continued)

### DAILY HISTORY

Is captured once each day and is saved at night, after 2 hours of no activity when the PV input voltage is below battery voltage for solar, or in modes that do not necessarily rest at night, like wind or hydro, the capture will happen once every 24 hours. Data logged each day is kilo-watt-hours, Float time in hours and minutes, the maximum power output for the day, maximum FET temperature inside the unit, maximum PV or input voltage and maximum battery voltage for the day.

### HOURLY HISTORY

Also referred to as “Short term History” is captured once every five 5 minutes anytime the Classic is not resting (when it is charging). Data logged every 5 minutes is power, input voltage, battery voltage, Charging Stage, amps out and kW-Hours.

A time and date stamp is associated with each data entry in both Daily and Hourly history logs. The main time/date stamp for each data logging mode is Date for daily history and Time for recent history although both time and date are stored and displayed for each logging mode.



Figure 13



## Just the Facts for the Classic (continued)

When entering the "LOGS" menu, you will see two items displayed there. The top line is lifetime kW-Hours for the Classic and below that is time spent in float today. (Note: Float, Absorb, Bulk and EQ time is also viewable in the "TIMER VU" sub-menu of the "ChgTime" menu in the main CHARGE menu) Pressing the SOFT LEFT key enters the DAILY history data viewing menu. Similarly, pressing the SOFT RIGHT key enters the HOURLY recent history data viewing menu.

In the DAILY menu, the LEFT side category of information displayed can be changed by pressing the UP or DOWN arrow keys. Switching over to the RIGHT side of the screen by pressing the RIGHT arrow key highlights the DAY change key. Pressing the UP key decrements the date (goes back 1 day) and displays that capture date above the word "DAY". There are 380 days of information stored in the Classic. After 380 days are captured and stored, the oldest data stored will be overwritten as new daily data fills in as the most recent data.

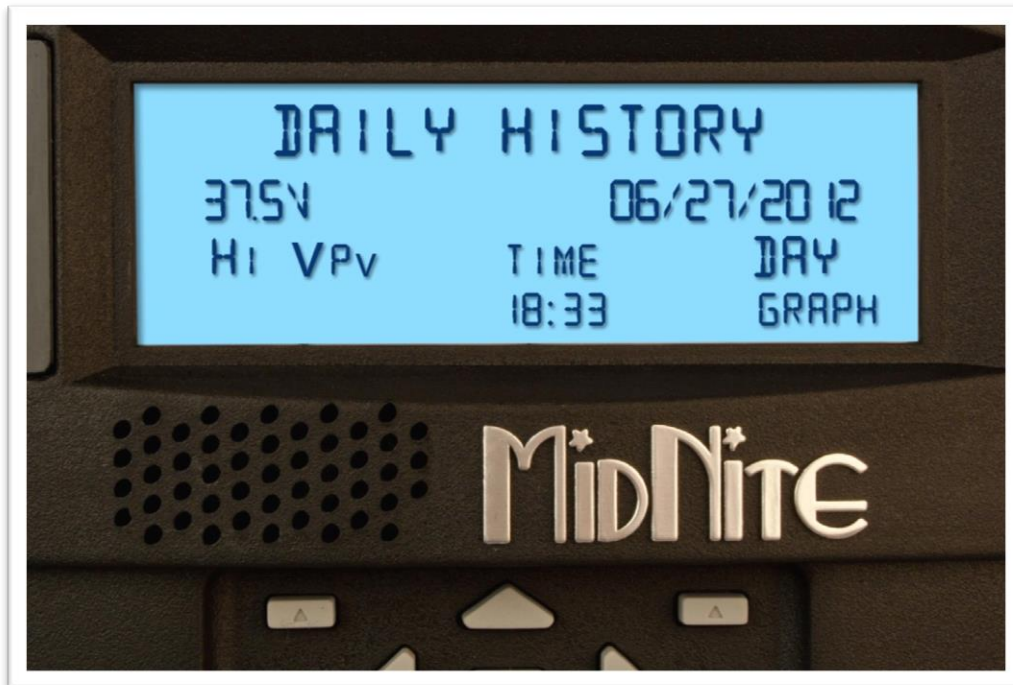

Figure 14

The HOURLY log menu (actually captured every 5 minutes), works very similar to the DAILY log menu, except that the time stamp above the word TIME is the time, shown in 24 hour format, that the data was captured that day. The category of data captured is of course more suited for minute by minute capture rather than the maximum data statistics captured on a day by day basis in the DAILY log screen. The left side of the recent history text log screen can be individually viewed by selecting the left side and pressing the UP/DOWN arrow keys to show the power, voltages, charge stage etc and various information captured at the time shown on the right side time selection.



Figure 15

At the bottom of the DAILY text log screen, the TIME the maximum statistics were stored is shown, whereas at the bottom of the HOURLY text log screen, the DATE of the capture is shown. Again, if for some reason the year of the time stamp was less than 2011, the time/date will alternate between INVALID and the time/date stamped along with that data and does not necessarily mean the data itself is not correct. If the data is all zeros and the year is shown as 2000, the data IS most likely invalid and not correct or the logging memory has not been filled yet. This is why the Classic powers up with the year 05/04/2003... It means that data was actually logged but the date was not set, whereas if it is showing 00/00/2000 it will normally mean that the data is just zero and therefore invalid data as well as invalid time and date.

The upper right corner of the text log screens displays a number from 1 to 380. This number shows the index or position of the data in the 380 data log time slots. The most recently stored data has an index of 1. Two data points ago shows an index of 2, etc. This index goes for either Daily History or Recent History text log viewing screen.

## Graphical Logging Display modes

Both DAILY and HOURLY logging can also be viewed in a graphical manner. While in the text viewing log screen, pressing the Soft Right key labeled "GRAPH" will bring up this view screen. The HOURLY view is also available in the main status cycle of screens, changed by repeatedly pressing the STATUS key, just after STATUS TWO screen. This is labeled as "SHORT TERM HISTORY" in the STATUS screens.

A summary of the next Status screen will be shown while holding the status button before releasing it and entering that next status screen. This also goes for the Recent History graph screen in Status.

Each data point shown in the graphical view screen is shown as a dot. There are a maximum of 96 dots, appearing horizontally per screen with some information about each dot shown on the left side of the screen. An individual data point can be selected for investigation by moving a small, flashing once per second vertical cursor horizontally across the graphed data by using the Left and Right arrow keys. The most recent data is shown on the right most

## Just the Facts for the Classic (continued)

side of the first screen. The cursor first appears around 20 dots or data points from the right side of the first screen. (About 20 data points ago in history)

To scroll the data viewed one third of a screen to the left, hold the “Shift” key, the “Soft Left button”, down and tap the “Left arrow key”. Each press of this combination of buttons will scroll the graphical view horizontally another 1/3 screen. Holding the Shift key and Right arrow key on the most recent data screen will push the cursor up against the right side and onto data point one.

Pressing the Up arrow button will change the data viewed to the next category. For instance, in the Recent history graph screen, the displayed data will change from Power to input voltage, battery voltage and kW-Hours. Pressing the Down arrow key will bring the category of data back down again. A very brief 5 or 6 character annunciator displayed in the upper left corner tells us what category of data the graph is showing us. The number just below this 5 or 6 character descriptions is the actual number in volts or watts or applicable unit of data displayed at that cursor position centered on the dot of the graph. The third line down on the left side of the recent data screen shows the time stamp of that data where the cursor is positioned on the graph. Finally, the bottom left of the graph screen alternates between two indicators. One is the charge stage at the cursor position and the other is the scaling of the vertical axis of the graph. Power for instance, can show a very wide range of values and power lends itself better to using a logarithmic vertical scale, shown as LOG. Voltage and other data shows up fine using a LINEAR vertical axis scale and is spelled out on the lower left of the graphic screen.

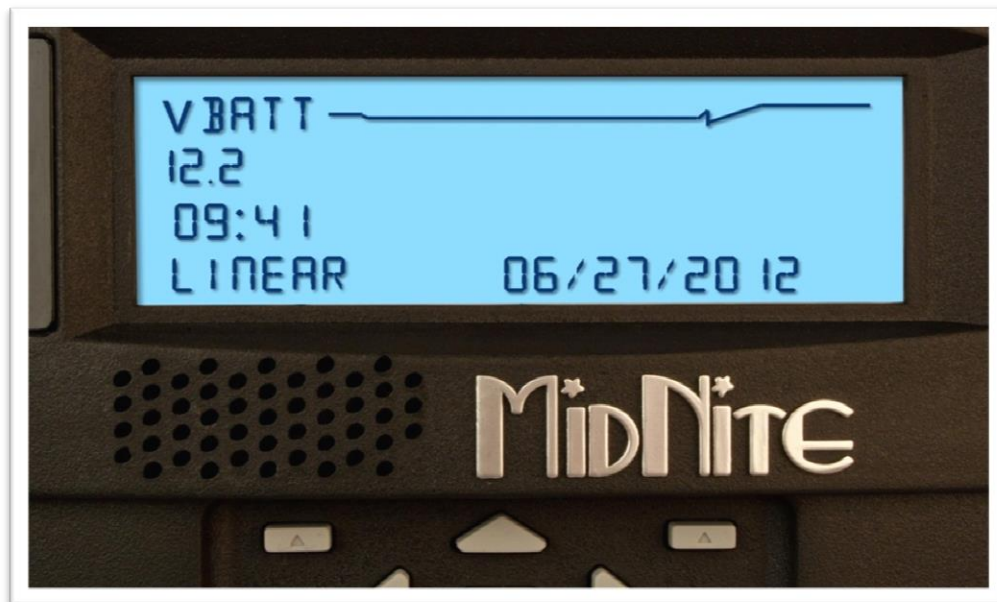

Figure 16

The Date of the particular selected cursor positioned data point is shown on the bottom middle of the graphic screen. Moving the cursor left or right using the Left and Right arrow keys, selects the next data points to the left or to the right of the present cursor position.

The flashing cursor is short and may be hard to detect at first so you may have to look for it. The cursor aligns and centers itself right on the dot itself that is selected.

## Just the Facts for the Classic (continued)

The bottom date or time displayed may tend to obscure the data line graphed behind it. The time/date and the graph data will be mixed together about a second after the date/time is drawn on the bottom of that graph log screen. If, for some reason, the graphic log screen display shows bogus data or dots that look like they should not be shown, simply press the Enter button and the screen will be quickly erased and re-drawn without the extra lines or dots.

There may or may not be any valid data past a certain point to the left if the unit is fairly new. The data shown in unused spots may be zero, or it may be off the screen and not viewable. As time goes on and new data is acquired, those unused data points will start to appear and be valid. Of course, the Daily history will take many days to fill in, where the Recent hourly (minutes really) data will fill in after a few hours or maybe a day or two depending on how long the Classic is on and running for that day. Remember, the Classic does not normally log data while it is in “Resting” mode.

For additional information on the Classic please refer to the “Classic User’s Manual” on the included DVD or the online version at [www.midnitesolar.com](http://www.midnitesolar.com)

### Troubleshooting

Classic display will not turn on when power is applied to the Classic but the fans do the self-test.	Display is plugged into the wrong jack.  Defective cable.	Make sure the display is plugged into the 1 <sup>st</sup> or 2 <sup>nd</sup> jack on the main board.  Any short 4 conductor phone cable can be used to test for this.
Classic will not power up and no self-test of the fans.	Insufficient battery voltage at the Classic terminals	Verify there is more than 10vdc at the Classic terminal block.
Classic says “Resting” and the sun is out.	Mode is turned Off  Insufficient voltage on the input of the Classic	Refer to the manual on turning the Mode on and saving the change.  Verify the Voltage on the input terminals of the Classic terminal block is greater than the battery voltage